

ECPE / COMP 177
Fall 2014

Computer Networking

→ Lab Essentials

Some slides from Kurose and Ross, *Computer Networking*, 5th Edition

Upcoming Schedule

- **Quiz Next Tuesday (10-15 minutes)**
 - Sockets, Application-Layer Protocol (HTTP)
- **Project #1**
 - Starts next Tuesday
 - **Is your Linux environment all ready?**
 - **Bring your laptop – Work time after quick discussion of project goals**
 - **Two weeks – Don't delay!**

Recap – Network Model

Application Layer

Transport Layer

Network Layer

Link Layer

Physical Layer

Recap – Application Layer

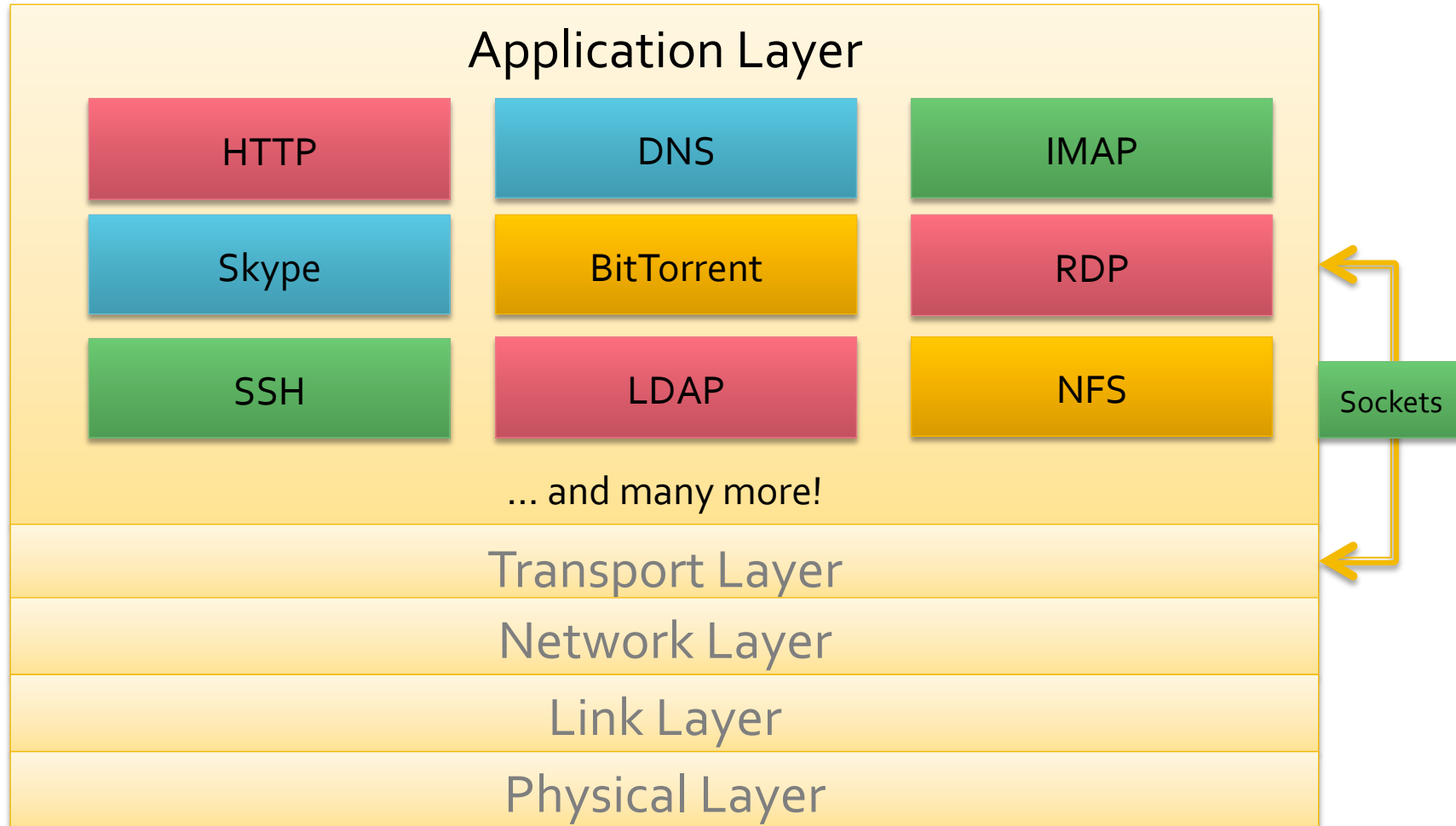

Recap – Transport Layer

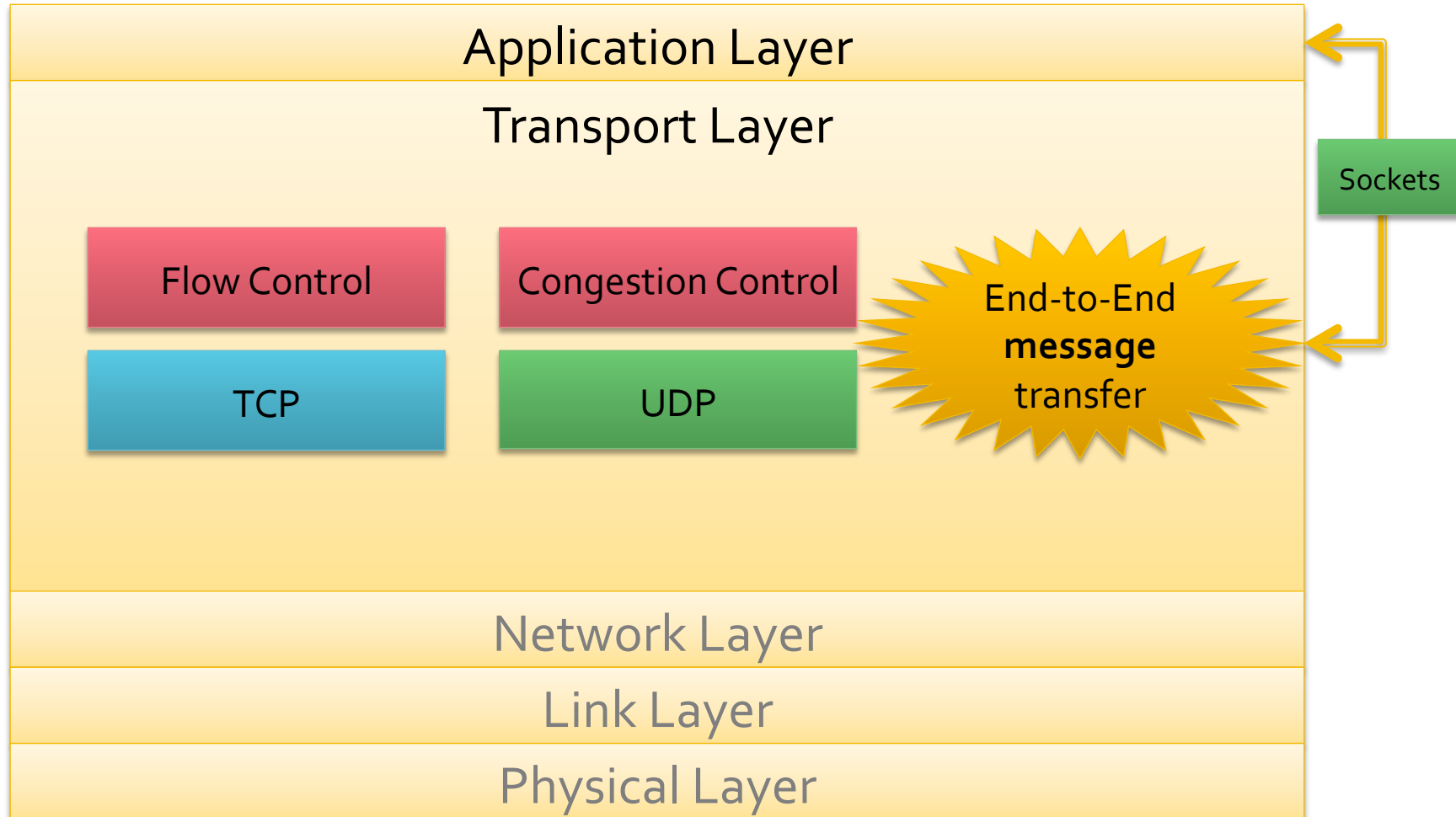

Recap – Network Layer

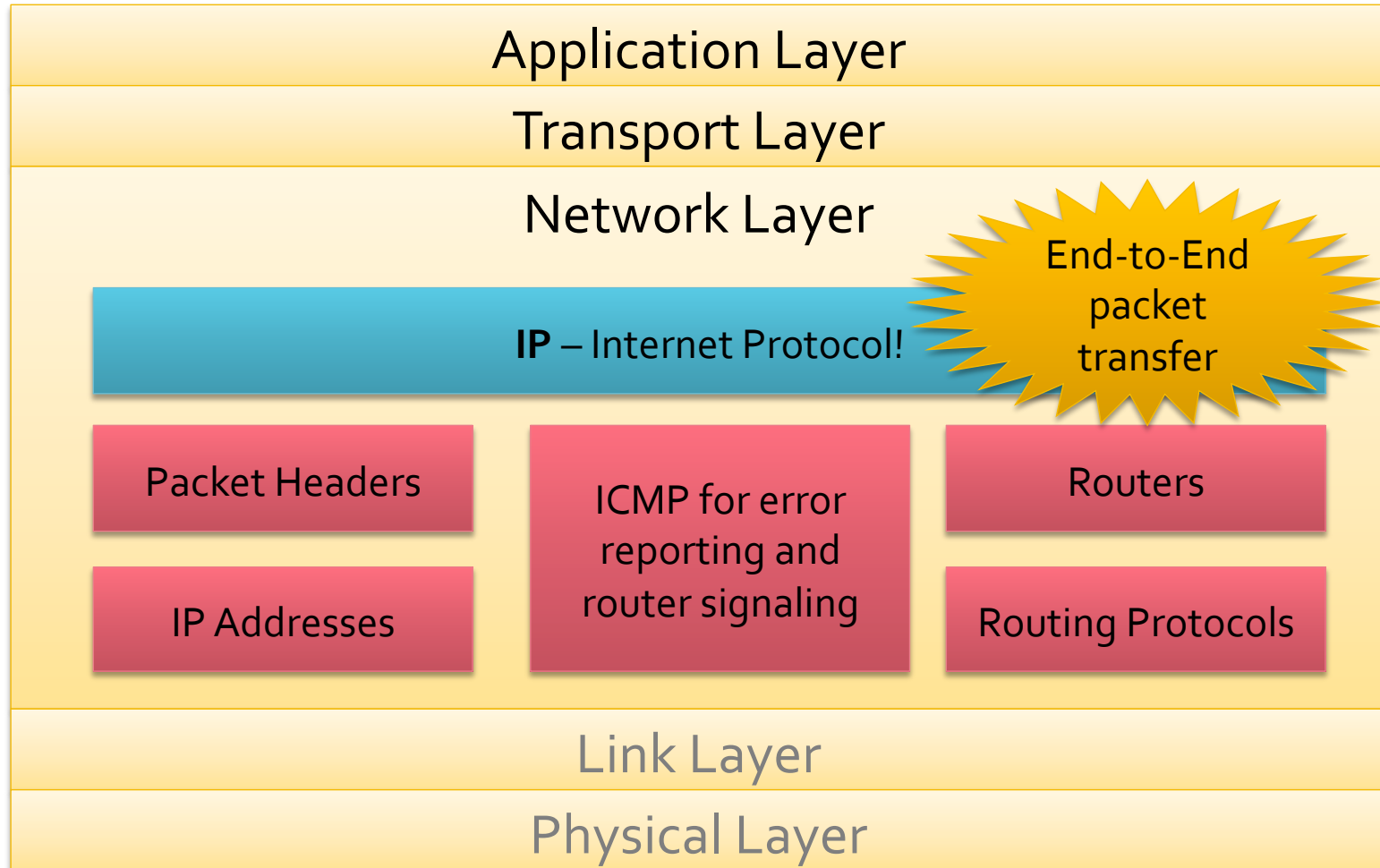

Recap – Link Layer

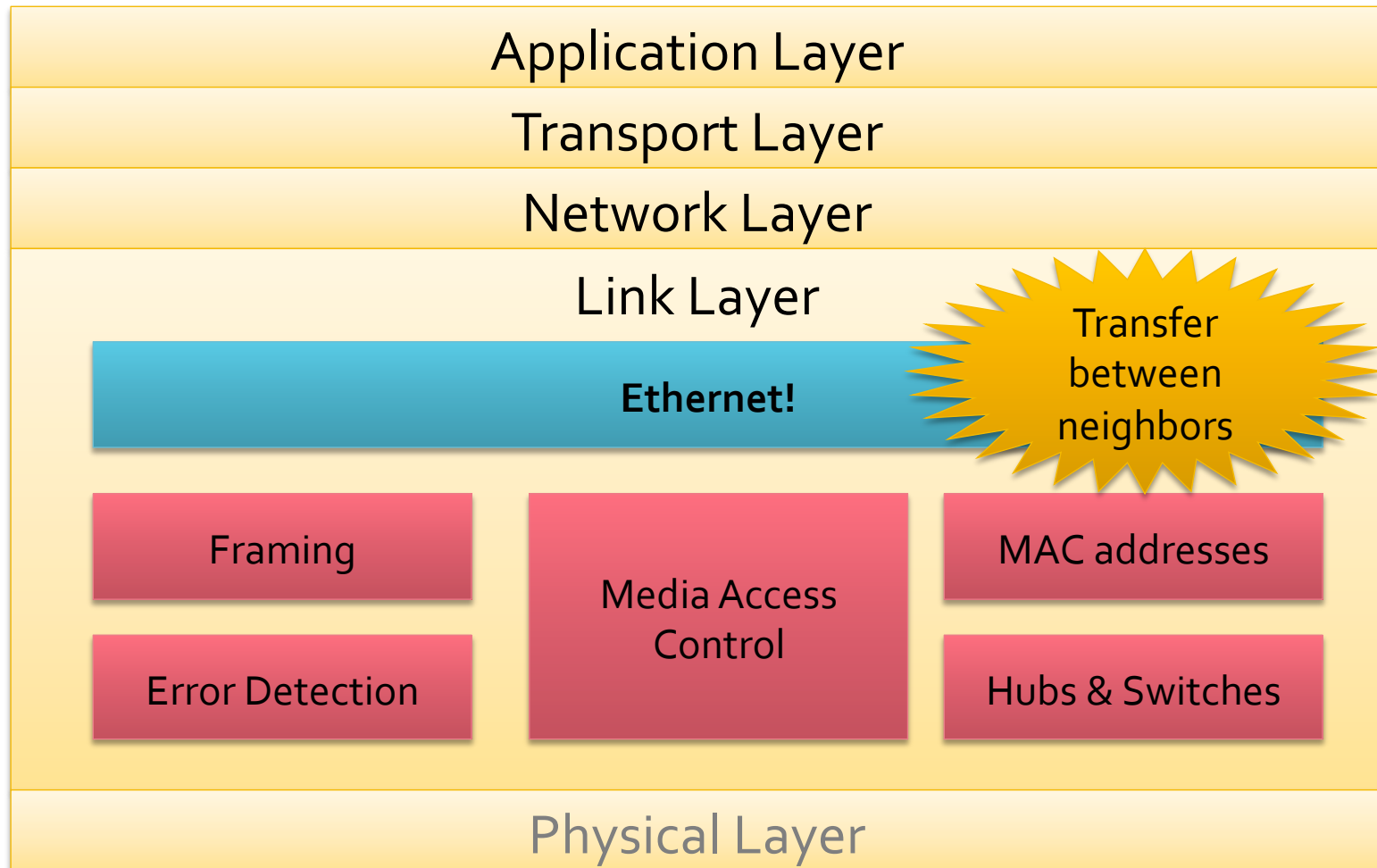

Recap – Physical Layer

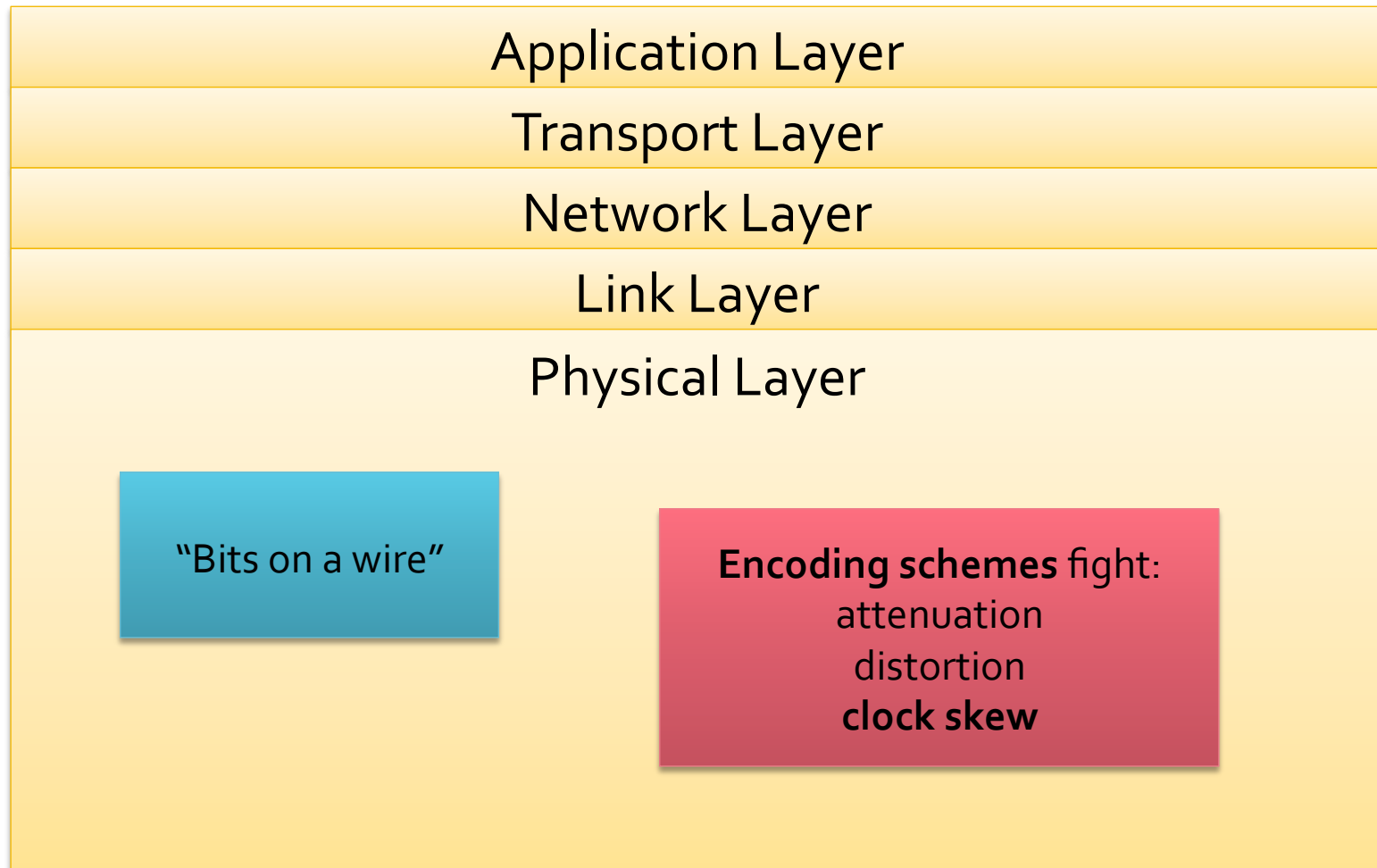

Lab Essentials - Motivation

- Course Organization – Top-Down!
 - Starting with Applications / App programming
 - Then Transport Layer (TCP/UDP)...
 - Then Network Layer (IP)...
 - Then Link Layer (Ethernet)...
- Challenge for Lab:
 - You're going to start using Ethernet/IP on the first day!
- Solution – 1-day overview of the **essentials**

Host Configuration

- My computer has several key network settings:
 - My Ethernet / **MAC address**
 - My **IP address**
 - **Netmask** of network I'm connected to
 - **Next-hop gateway** IP address of network I'm connected to
- What do these mean?

Ethernet Basics

The Link Layer

Local Area Network

- Goal: Connect computers across a **Local Area Network**
 - Room?
 - Floor?
 - Building?
 - Few buildings?
- Natural size limit to Ethernet-only networks
 - *Will discuss reasons why later this semester*

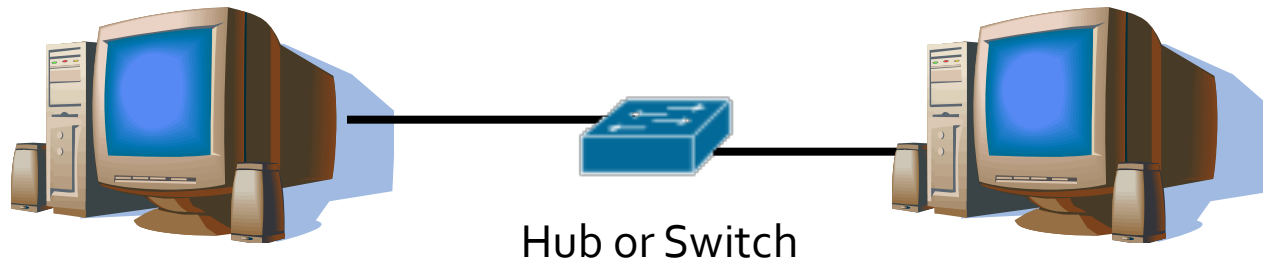

Ethernet - Addressing

- Each device on the network needs a **unique address**
- All Ethernet devices have globally unique 48-bit address assigned by manufacturer
 - Upper 24 bits – Manufacturer
 - Lower 24 bits – Unique device by manufacturer
 - The **MAC address**
- Example: 0x 00-07-E9-CB-79-4F
 - 0x 00-07-E9 = Intel Corp (assigned by IEEE)
 - 0x CB-79-4F = Unique address per NIC (picked by Intel)

This is where "my"
MAC address comes
from

Ethernet Frame Format (Simplified)

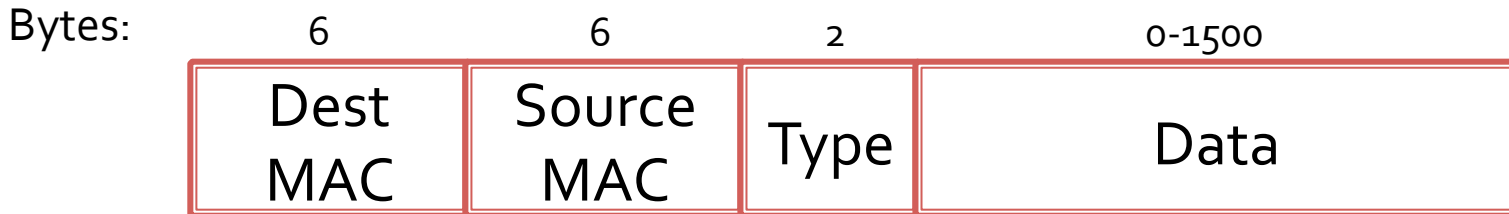

- Two MAC addresses saved in Ethernet frame
 - **Destination MAC** – Where is this frame going **to**?
 - **Source MAC** – Who sent this frame?
- Type: Indicates data type or length in bytes
- The Data!
- *Note: The above view is simplified...*

Topology

- So how do I connect dozens of computers together?
 - My cable only has two ends...



Ethernet Hub vs Switch

Ethernet Hub

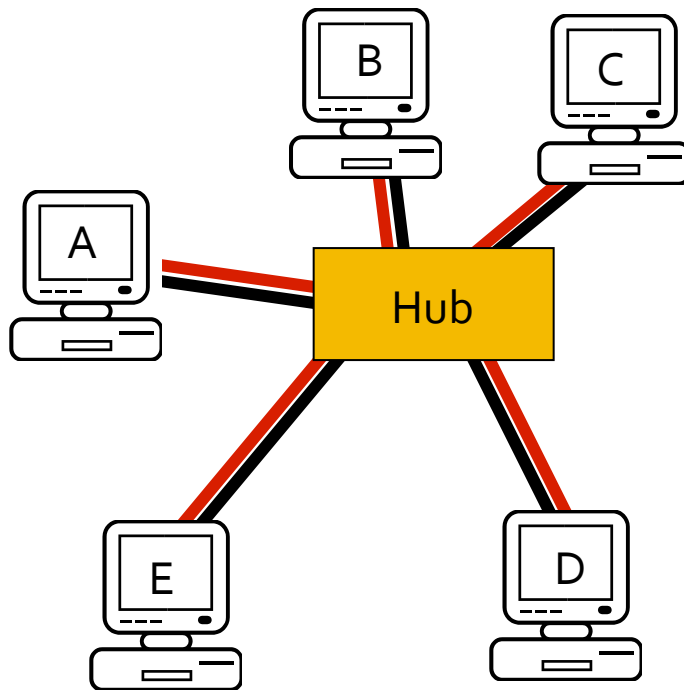

A transmits to D
D replies to A

Ethernet Switch

(assume learning already occurred)

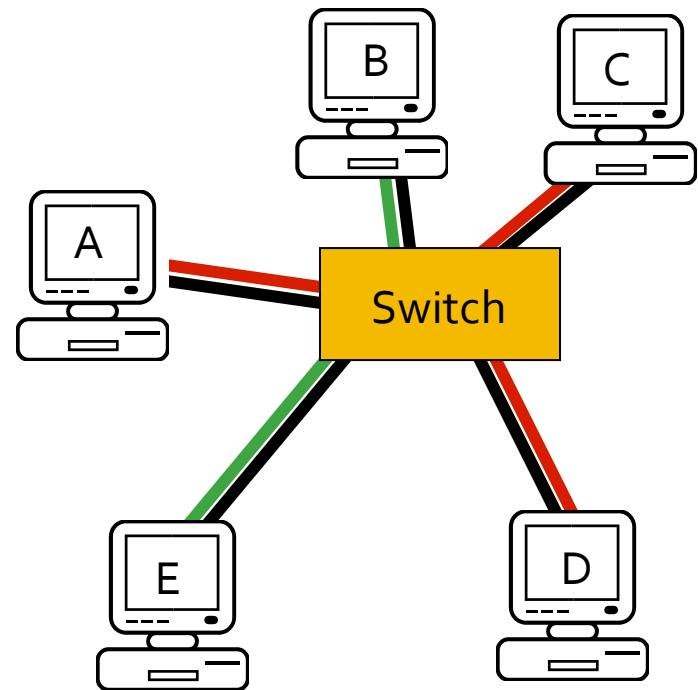

A transmits to D
D replies to A
E transmits to B,
and A to C

Internet Protocol (IP) Basics

The Network Layer

The Internet Protocol - Motivations

- Ethernet is sufficient for a local-area network
- IP is needed for a global network (the **Internet!**)

IP Properties

- Datagram
 - Each packet is individually routed
 - Packets may be fragmented or duplicated
 - Due to underlying networks
- Connectionless
 - No guarantee of delivery in sequence
- Unreliable
 - No guarantee of delivery
 - No guarantee of integrity of data
- Best effort
 - Only drop packets when necessary
 - No time guarantee for delivery

This is no different from standard Ethernet networks!

IP Addresses

- IP version 4 addresses are 32 bits long
 - *Version 6 address are 128 bits*
- Every network interface has at least one IP address
 - A computer might have 2 or more IP addresses
 - A router has many IP addresses
 - These addresses can be assigned statically or dynamically

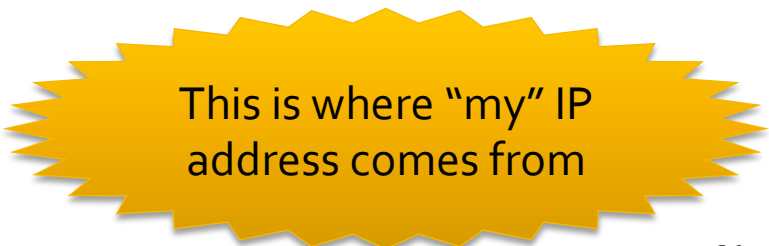
A yellow starburst-shaped callout box with a jagged, sunburst-like border. It contains the text "This is where 'my' IP address comes from" in a black, sans-serif font.

This is where "my" IP address comes from

IP Address Format

- IPv4 addresses are usually displayed in dotted decimal notation
 - Each byte represented by decimal value
 - Bytes are separated by a period
 - IP address $0x8002C2F2 = 128.2.194.242$

IP Packet Format (Simplified)

- Two IP addresses saved in packet
 - **Destination** IP address
 - Where is this packet going to?
 - **Source** IP address
 - Who sent this packet?
- Checksum
- Length
- Other fields
- The Data!

IP and Ethernet (Simplified View)

- IP datagrams can be *encapsulated* in Ethernet frames

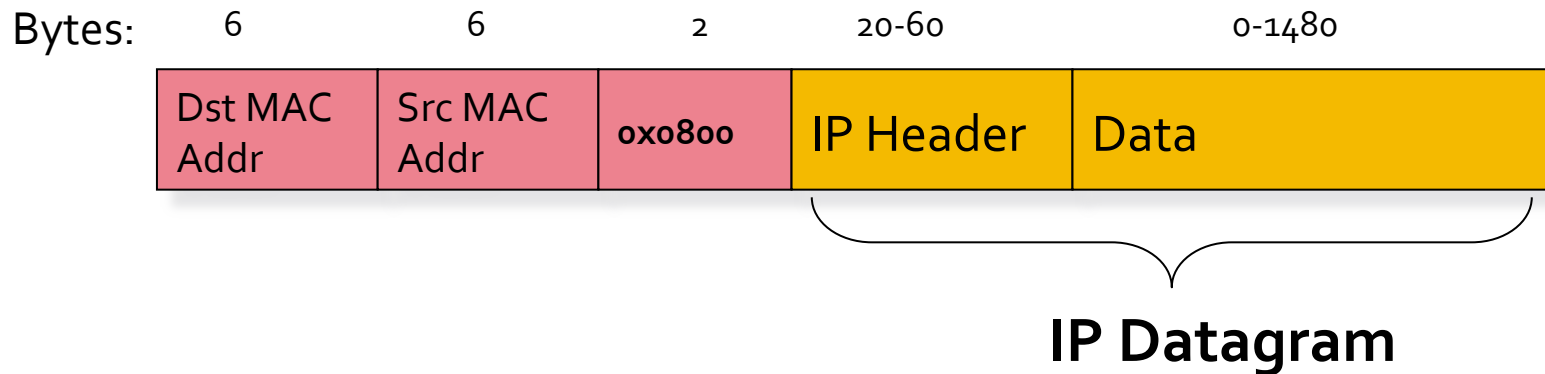

- So what is sent on the *wire* is an **Ethernet frame**
 - Inside of which is an **IP packet**...
 - Inside of which is the **transport layer**...
 - Inside of which is the **application layer**...

Host Configuration

- My computer has several key network settings:
 - My Ethernet / **MAC address** ✓
 - My **IP address** ✓
 - **Netmask** of network I'm connected to
 - **Next-hop gateway** IP address of network I'm connected to
- What do these mean?

Subnet

- A small network that is part of a larger network
- A collection of computers (*probably in the same physical area*) that have similar IP addresses

All computers in this *subnet* have IP addresses of the form **138.9.125.x**

Note: There is no rule that says subnet addresses have to be at 8-bit boundaries!

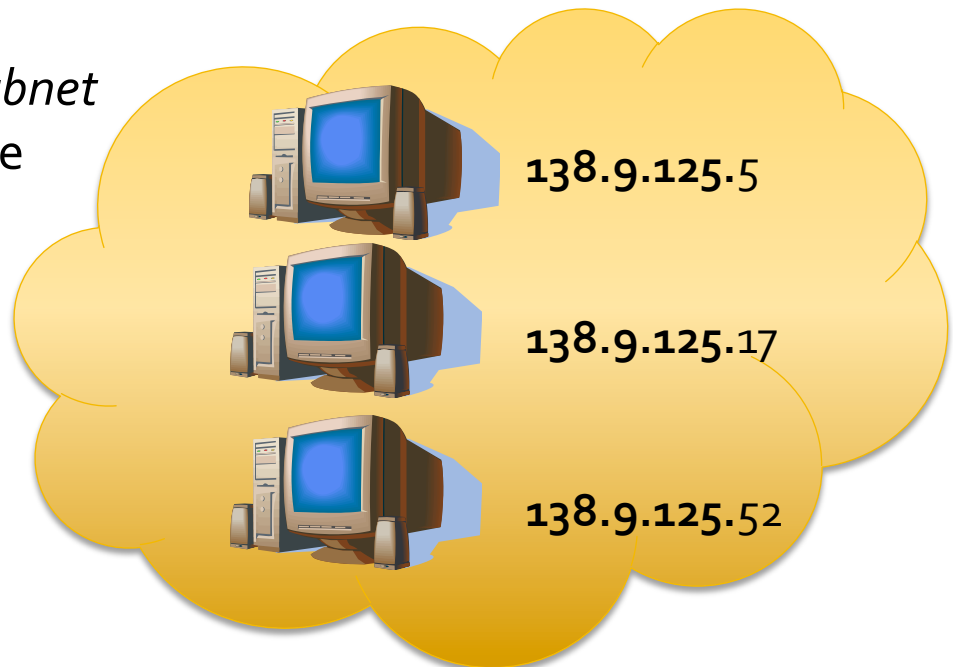

Subnet Notation

- A.B.C.D/X
 - IP address of the subnet (with 0's in all host ID bits)
 - X = number of bits in the subnet network address
- Examples:
 - 17.0.0.0/8 – Apple's entire class A address space
 - 17.2.3.0/24 – A class C sized subnet in Apple's network
- Can also be represented by subnet IP and a bit mask (netmask)
 - 17.0.0.0/255.0.0.0
 - 17.2.3.0/255.255.255.0
- Network specified by network operator

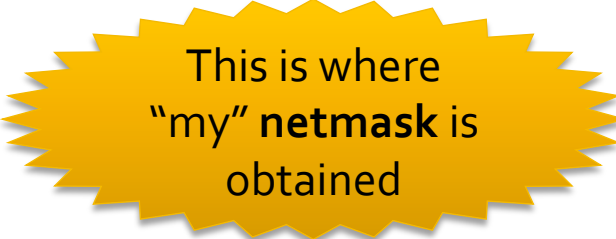

This is where
"my" netmask is
obtained

Host Configuration

- My computer has several key network settings:
 - My Ethernet / **MAC address** ✓
 - My **IP address** ✓
 - **Netmask** of network I'm connected to ✓
 - **Next-hop gateway** IP address of network I'm connected to
- What do these mean?

Routers

- “Similar” to switches, but only at a high level
 - Packet comes in
 - Switch/router looks up the destination address
 - Packet forwarded out correct port
- Key difference #1: Routers forward based on IP addresses!
 - Router works at *network* layer, switch works at *link* layer



Routing Between LANs

This is where "my" netmask and next-hop gateway are used

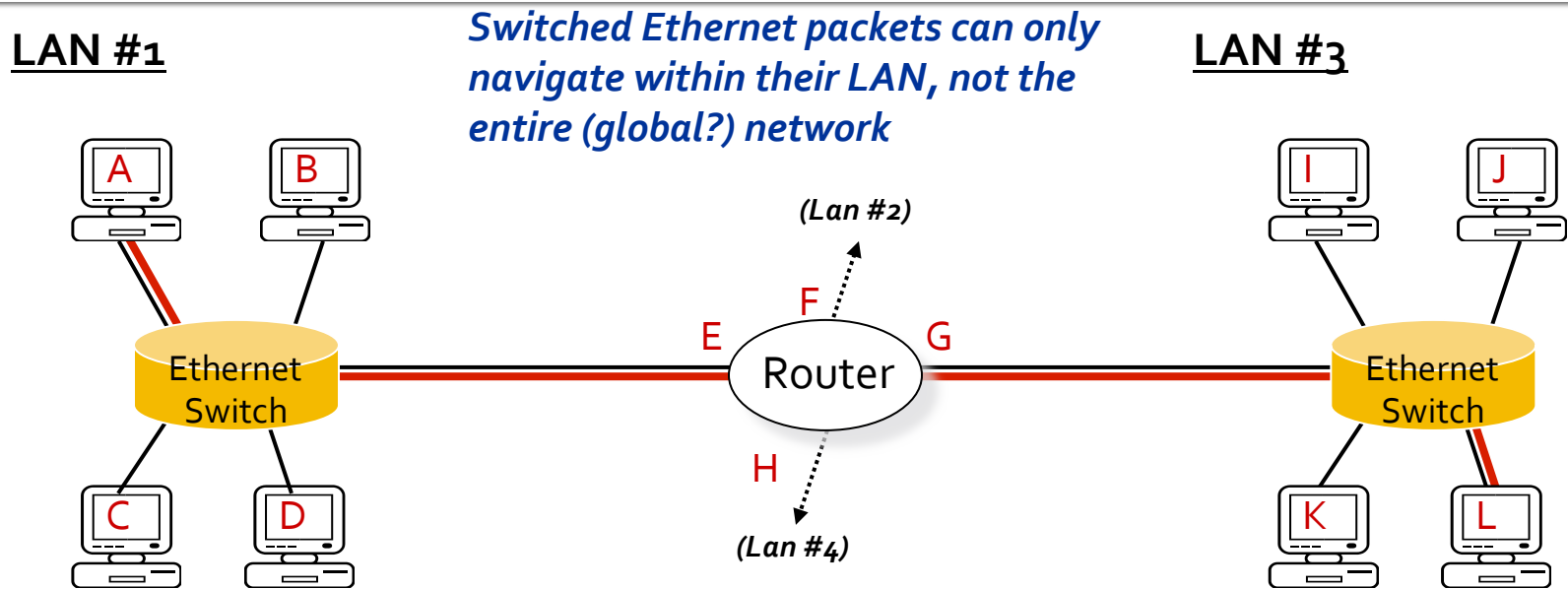

Switched Ethernet packets can only navigate within their LAN, not the entire (global?) network

(1) A transmits to L using higher-level protocol (e.g. IP)
Ethernet frame destination is router

(3) Router uses higher-level protocol (e.g. IP) to determine destination, and updates Ethernet frame destination, source and CRC

Frame:

DA (E)	SA (A)	Type / Data	CRC
--------	--------	-------------	-----

(2) Switch forwards frame to router

Frame:

DA (L)	SA (G)	Type / Data	CRC
--------	--------	-------------	-----

(4) Switch forwards frame to destination

ARP Basics

Address Resolution Protocol

Address Resolution Protocol

- Find link layer address given a network layer address
 - i.e., what is the **Ethernet address** for a given **IP address**?
- Every IP node (hosts and routers) has an ARP table
 - Mapping from IP to Ethernet addresses on their LAN
 - May be incomplete
 - Can include both static and dynamic entries

Dynamic ARP Entries

- Systems “discover” IP → Ethernet address mappings, as needed
- Each entry has an IP address, an Ethernet address, and a timeout (typically around 20 minutes)
- ARP messages are **broadcast** on the LAN to discover mappings
 - All computers on the network receive the ARP requests

Learning MAC addresses

- Hosts learn IP → Ethernet address mappings
 - ARP responses are stored in ARP tables
 - ARP requests are stored in ARP tables (whether the host is the target or not!)
- ARP entries time out
 - Allow machines to change IP and/or MAC addresses transparently
 - Eliminate stale entries (machines turn off, move, crash, etc.)

Recap

Networking Essentials for Lab

Recap – Forwarding

- **What field do Ethernet switches forward data on?**
 - Destination MAC address (in Ethernet header)
- **What field do IP routers forward data on?**
 - Destination IP address (in IP header)

Recap – Addresses

- **How many bits long is a MAC address?**
 - 48 bits
 - Example: 0x 00-07-E9-CB-79-4F

- **How many bits long is an IPv4 address?**
 - 32 bits
 - Example: 138.9.215.87

Recap

- “My” MAC address
 - Comes from?
 - Used in?
- “My” IP address
 - Comes from?
 - Used in?
- “My” Netmask
 - Comes from?
 - Used in?
- “My” Next Hop Gateway
 - Comes from?
 - Used in?